



FEDERATION INTERNATIONALE DE L'AUTOMOBILE

**Guide and installation specification for HANS®
devices in racing competition**

March, 2022

Contents

Foreword.....	3
1. HANS® selection.....	3
1.1. HANS® angles	3
1.2. HANS® wings or tabs	4
1.3. HANS-yokes brackets	5
2. Preparation of a the HANS® device	5
2.1. Friction rubber	5
2.2. Padding.....	5
2.3. FHR tethers length	6
3. Helmets to use with a HANS® device.....	6
4. Installation	7
4.1. Seats	7
4.2. Harness.....	7
4.2.1. <i>Harness restrictions</i>	8
4.2.2. <i>Position of adjusters for harnesses with 5, 6 or 7 attachment points to the vehicle</i>	9
4.2.3. <i>Position of adjusters for harnesses with 8 or 9 attachment points to the vehicle</i>	10
4.2.4. <i>Shoulder belt angles for harnesses with 5, 6 or 7 attachment points to the vehicle – top view</i>	10
4.2.5. <i>Shoulder belt angles for harness with 5, 6 or 7 attachment points to the vehicle– side view</i> ..	11
4.2.6. <i>Shoulder belt angles for harnesses with 8 or 9 attachment points to the vehicle – side and top view</i>	12
4.3. Headrests and cockpit surrounds with HANS®	13
4.4. Car evacuation with HANS®	13
5. Life of HANS®	13

Foreword

A Frontal Head Restraint (FHR) **device** restrains the driver's head relative to his torso during a frontal or angled-frontal impact thereby, reducing the loads to the head and neck.

~~There are different~~ **Different** types of FHR systems **are** approved, ~~by~~ one of them being the HANS®.

This document aims to give some basic guidelines on the aspects to take into account when selecting and using a HANS® for racing competitions. These guidelines apply to HANS® approved according to FIA Standards 8858-2002 and 8858-2010 that are included in Technical List n°29 available ~~in~~ **on** the FIA website www.fia.com under the homologations section.

1. HANS® selection

When choosing a HANS® **device** there are safety aspects that need to be considered. In addition comfort and weight will also help ~~on~~ **in** the selection. Drivers must ensure that they use an appropriate HANS® device. Specifically, the HANS® collar angle and HANS® width shall be appropriate for the **seated sitting** position and the driver's size.

1.1. HANS® angles

HANS® devices exist not only in different sizes, but also with different angles between the yoke (part of the HANS® in contact with the driver's shoulders and chest) and collar (part of the HANS® located behind the driver's helmet). Normally HANS® devices exist in a range of angles between 10° **and to** 40°, and sizes from small to large. The manufacturer or distributor should be consulted on the best model for the motor sport activity and car concerned regarding seating position and body shape.

When seated in **the** racing position with its harnesses tightened, the HANS® collar angle must be between 60° and 90° from the horizontal (see Figure 1 and Figure 2).

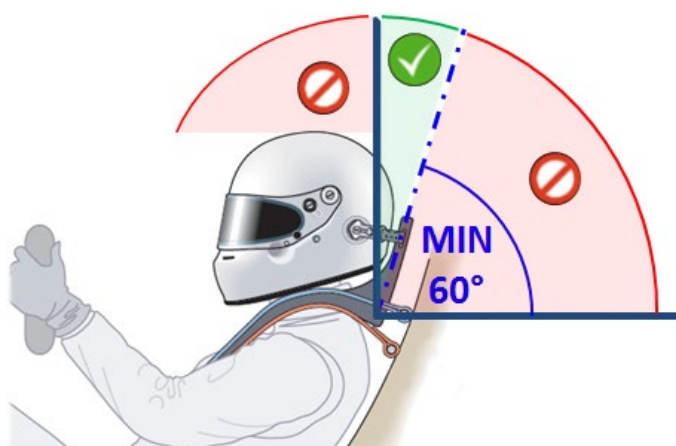

Figure 1 Collar angle

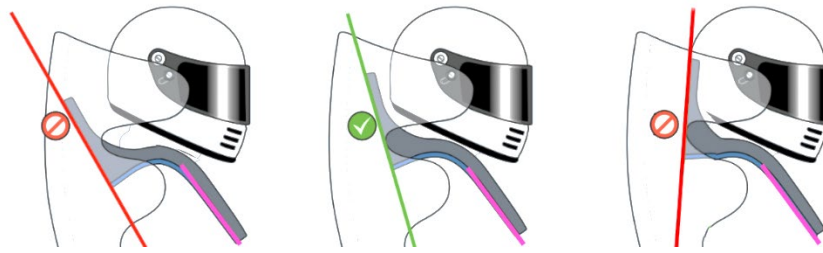

Figure 2 Examples of incorrect and correct HANS® angles

The HANS® device may lightly contact **the** helmet, but if the HANS® collar angle is **greater higher** than 90° from the horizontal (the top of the collar is pointing forward instead of pointing backwards) a more upright device may be required (for example from a 30° HANS® to a 20 HANS®).

The HANS® device may lightly contact the seat or headrest but if the HANS® pushes the head forward uncomfortably, the HANS® collar top goes backwards in an angle from the horizontal lower than 60°, a HANS® model with a higher angle may be required (for example from a 20° HANS® to a 30 HANS®).

The next drawing **Figure 3** shows an indication of models angles according to sitting position.

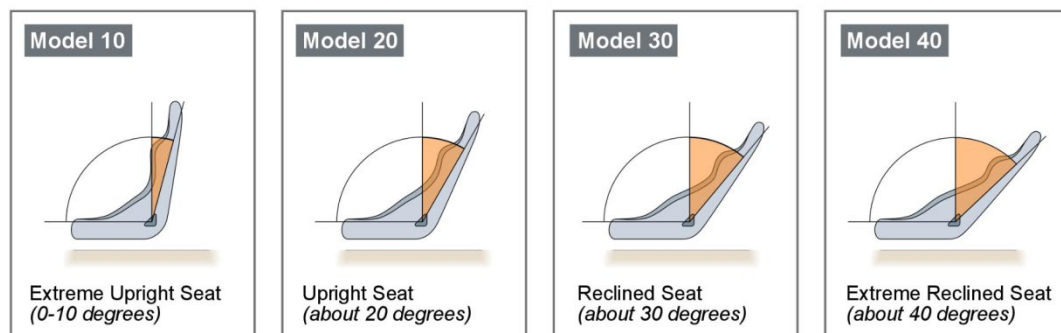

Figure 3 HANS® models denomination according to sitting position

1.2. HANS® wings or tabs

Some HANS® models have a small tab at the upper part of the HANS-yoke on the side, in order to reduce the lateral movement of the shoulder belts (see Figure 4). If the driver is facing problems of the shoulder belt tending to come out of the HANS-yoke, these models may reduce this effect (see also Article [4.2.4 4.2.3](#)).



Figure 4 HANS® device model with small tabs on the side of the upper surface of the yokes

1.3. HANS-yokes brackets

The FIA authorises the HANS® device manufacturer~~s~~ to add brackets to the bottom part of the HANS-yoke (see Figure 5) in order to prevent the shoulder straps from coming out of the HANS-yoke (see also Article ~~4.2.4~~ 4.2.3). The manufacturer or supplier should be consulted on the models with this option available.

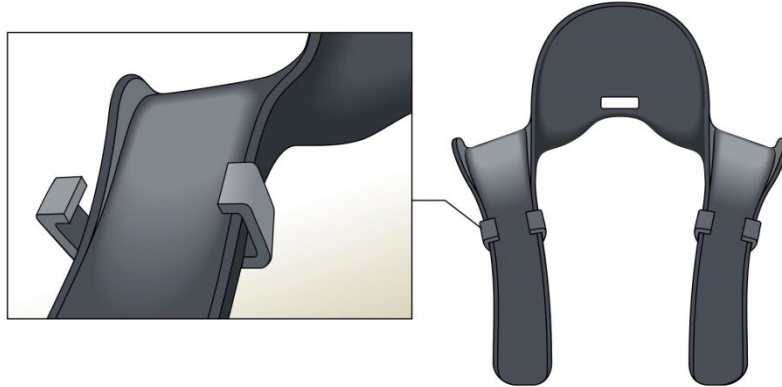

Figure 5 HANS® device with additional small brackets at the yokes

2. Preparation of ~~a~~ the HANS® device

The body of the HANS® Device must never be modified but there are some aspects that can be taken into account to prepare the HANS®.

2.1. Friction rubber

The surface of the HANS-yokes in contact with the harness belt must be ~~provided by the manufacturer~~ covered with a high friction rubber to grip the lower surface of the shoulder straps. The friction material ~~should~~ **shall** not be removed. The condition of the rubber surface ~~should~~ **shall** be monitored – no breakage, ripping, tears or other damage is acceptable. In case of repair, it must be done only if the manufacturer ~~so~~ recommends, ~~so~~ and strictly in accordance with the manufacturer's instructions. In case a rubber replacement is possible, ~~the~~ FIA strongly recommends ~~that for~~ this operation to be carried out by device's manufacturer.

If the HANS® is painted (only in conformity with the manufacturer's instructions) ~~it is essential that~~ the rubber ~~is~~ **shall be** left completely uncovered to ensure that the friction with the shoulder belts is not compromised. Any painted HANS® must respect the flame resistance requirement of FIA Standards 8858-2002 and 8858-2010.

2.2. Padding

Padding is authorised only in ~~the~~ between the device and the driver. It is recommended that the surface of the HANS® in contact with the driver's body is padded for comfort. Any padding used between the driver and the HANS-yoke must not be more than 15 mm thick when the driver is seated in the car fully equipped with the harness tightened. The padding must be covered by a

flameproof material, and the padding must not be wider than 8 mm on each side of the HANS-yoke as shown in Figure 6 (see Article 3.1 of the Chapter III “Drivers’ Equipment” of the Appendix L to the International Sporting Code).

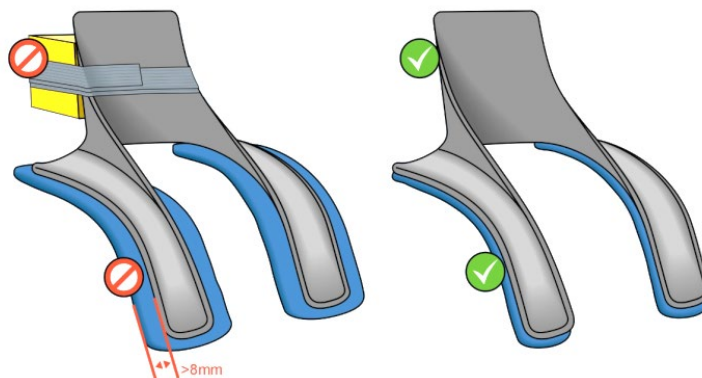

Figure 6 Examples of incorrect and correct HANS® padding

2.3. FHR tethers length

It is not recommended to fit the FHR tether(s) very short and tight.

There are HANS® devices with sliding tethers and HANS® devices with fixed tethers. In case of fixed tethers, the two tethers should be adjusted to the same length.

A nominal length is 150mm. A tolerance of +/- 25mm is acceptable. The nominal length shall be measured as follows following:

- the driver shall be seated in the car in the normal driving position, wearing the HANS® and helmet, and with the safety harness fastened;
- the driver should lean his/her body and head forward as far as possible - in this position the length must be measured from the leading edge of the HANS collar to the point of connection to the outside of the helmet.

The condition of the FHR tether(s), including the FHR end-fitting and clamping brackets, and the screws securing them to the back of the HANS® should shall be closely monitored, and they should shall be replaced if any wear is observed.

Please refer to FIA Technical List No. 29 for further details of approved tether end fittings and their marking.

3. Helmets to use with a HANS® device

An FIA-approved helmet according to FIA standards 8858-2002, 8858-2010, 8860-2004, 8860-2010, 8860-2018 or 8859-2015 is required. Please refer to FIA Technical Lists 33, 41, 49 and 49 69 for a full list of helmets approved for FHR use (including the HANS® use). Helmets with an FIA label 8858-2002 or 8858-2010 are only valid when they also have a Snell sticker. Therefore, only helmets with a Snell valid certification can be acceptable.

It is important to take into consideration the following dates:

- ~~Helmets approved in accordance with SA2005 certification will not be valid after 31.12.2018 even if they have a FIA 8858-2002 or 8858-2010 label. Technical list 41 details to what Snell standard the homologation was based on.~~
- ~~Helmets approved according to FIA standard 8860-2004 will not be valid after 31.12.2020~~
- Helmets approved according to FIA standards 8858-2002 or 8858-2010 will not be valid after **31.12.2023**, independently of what Snell Certification they may have.

The HANS® device shall always be used together with the helmet and shall be properly fitted (FHR tether end fittings clipped on the helmet and HANS-yoke under the seat belt).

Therefore, whenever a helmet is not worn, for example on rally liaison sections, the HANS® shall also be removed ~~also~~.

4. Installation

4.1. Seats

When using a HANS® with a saloon ~~salon~~ car, a ~~a~~ safety seats homologated according to FIA standard 8855-1999, 8855-2021 or 8862-2009 must be used.

In these cases, it is important to make sure that the shoulder straps run freely between the seat shoulder slots. It is therefore recommended to centre the belt ~~traps~~ straps in the slots ~~so~~ such that they do not touch the edges of the slots, as shown in Figure 7.

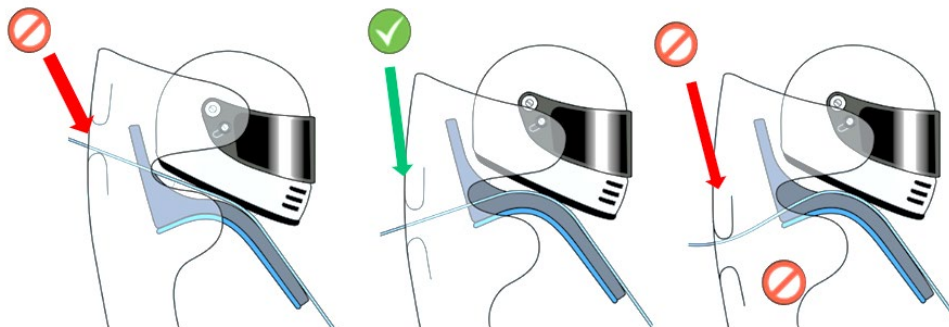

Figure 7 Example of incorrect~~ly~~ and correct~~ly~~ positioning of the harness straps in the seat slots

As ~~commented~~ described in section 1.1, the seat may determine ~~define~~ the HANS® angle to be used.

4.2. Harness

The safety belts to be used must be minimum five-point harnesses homologated to FIA standard 8853/98 or 8853-2016.

Drivers must ensure that **the harness they** remains properly tightened all the time, and that the HANS® is under the shoulder straps as shown in Figure 8 (see **next** section 4.2.1 for exception of the double shoulder belt harnesses).

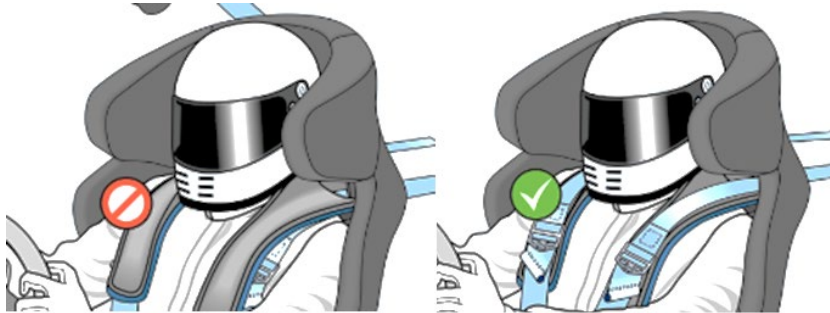

Figure 8 Example of **incorrectly** and **correctly** positioning of the harness straps when using a HANS®

Teams shall pay particular attention to the installation of the shoulder straps and the position of the buckle.

The buckle position is regulated by Article 253.6.2 of Appendix J to the **2022 2016** FIA International Sporting Code. See below extract of the related regulation:

“Article 253.6 Safety Belts

(...)

The lap straps must fit tightly in the bend between the pelvic crest and the upper thigh. Under no conditions must they be worn over the region of the abdomen.”

Some teams tend to fit **bungees bungies** on the shoulder belts in order to move them to the side of the seat. However, this also moves the shoulder belt sideways, **so such** that the belt comes out of the HANS-yoke. **Competitors shall** ~~Do~~ NOT fit bungees **on the shoulder belts**.

4.2.1. Harness restrictions

HANS® **device** can be used with harness models that are homologated with the standard shoulder strap width of a minimum of 70mm, as well as with models that are homologated with specific shoulder strap width of a minimum of 44mm, and that are marked "for FHR use only" or "for HANS use only".

FIA Homologated double shoulder belt systems are also allowed. **These They** are safety harness systems with two straps on each shoulder. They provide one body-belt that is positioned on the driver's shoulders (beneath the HANS®) and a second HANS-belt that is positioned on the HANS-yokes (as for standard HANS® use). It is important that the HANS-belt is at least as tight as the body-belt. An example of the double belt system is shown in Figure 9.

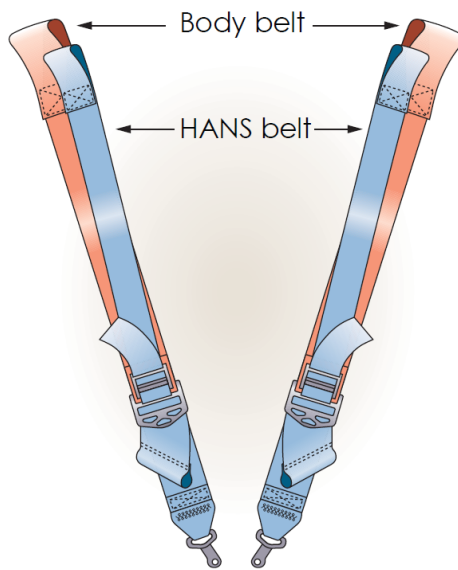

Figure 9 Double shoulder belt system

4.2.2. Position of adjusters for harnesses with 5, 6 or 7 attachment points to the vehicle

If the length adjustment device of the shoulder belt is positioned on the HANS-yoke then the upper edge must be not more than 70mm from the lower edge of the HANS-yoke as shown in Figure 10 (this does not apply in the case of the double shoulder belt system described in point 4.2.1).

If the length adjustment device of the shoulder belt is positioned between the HANS-yoke and buckle, it must be lower than the HANS-yoke **by** at least **by** 25mm.

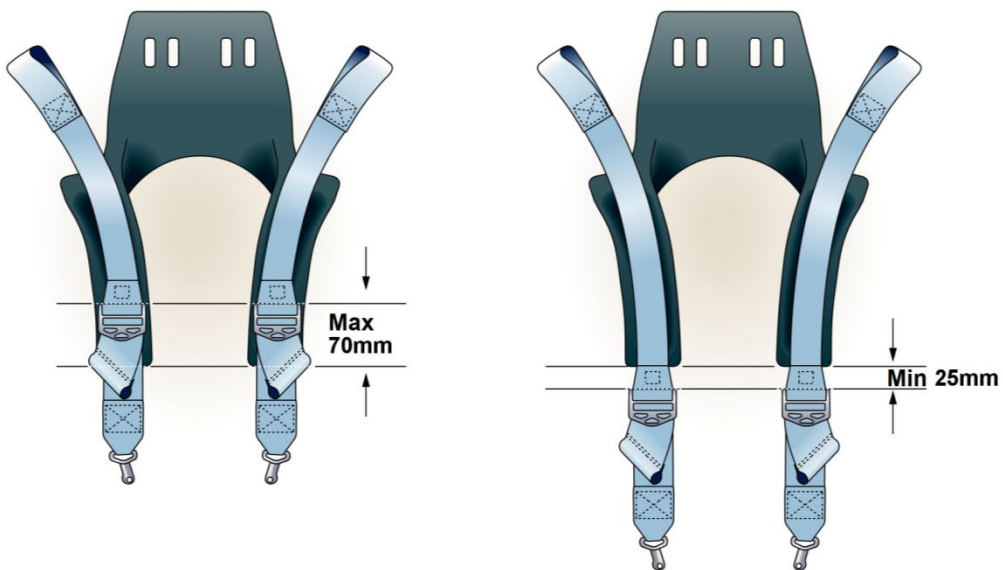

Figure 10 Correct position of shoulder strap length adjustment device on HANS-yoke

4.2.3. Position of adjusters for harnesses with 8 or 9 attachment points to the vehicle

When using double shoulder belts, there MUST be a minimum distance (B) between the lower edge of the HANS-yokes and the merging of the two belts where the HANS-belt is sewn to the body-belt (see Figure 11).

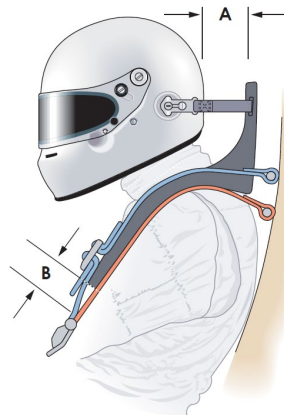

Figure 11 Minimum distance between HANS-yokes and double-shoulder belt merge point

The minimum distance (B) shall be determined as follows:

- the driver shall be seated in the car in the normal driving position, wearing the HANS® and helmet and with the safety harness fastened;
- the driver should lean his/her body and head forward as far as possible - in this position the horizontal distance from the front surface of the HANS-collar to the rearmost point of the helmet shall be measured (distance (A));
- minimum distance $B = 100\text{mm} - \text{distance (A)}$.

4.2.4. Shoulder belt angles for harnesses with 5, 6 or 7 attachment points to the vehicle – top view

The shoulder belt anchorage points on the car shall be symmetrical about the **centre center** line of the driver's seat. When viewed from above, it is recommended that the angle between the belts be approximately 20°-25°, as shown in Figure 12 and never out of the 10°-25° range. Belts may touch, or even be crossed over each other if necessary.

It is important to make sure that the shoulder straps attachment cannot slide laterally.

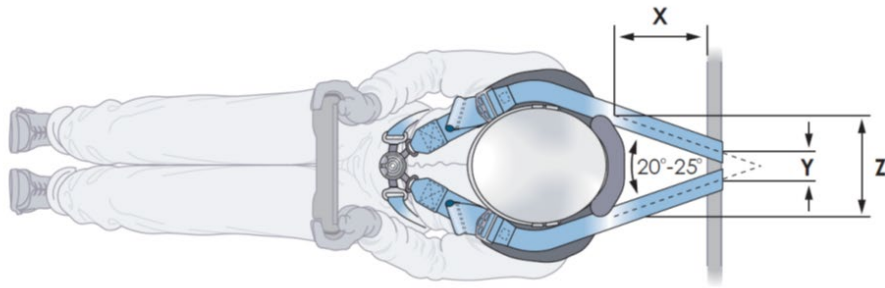

Figure 12 Position of shoulder belt anchorage points to achieve desired belt angle (plan view)

4.2.5. Shoulder belt angles for harness with 5, 6 or 7 attachment points to the vehicle— side view

When using a HANS® with a **saloon** car, ~~it is recommended that~~ the rear section of the shoulder strap **shall be directed** slopes downwards from the uppermost point of contact with the HANS-belt-bearing-surface to the anchorage point on the car, preferably at about 20° below the horizontal; **acceptable** angles **between 0° and 20° being acceptable as are** shown in Figure 13.

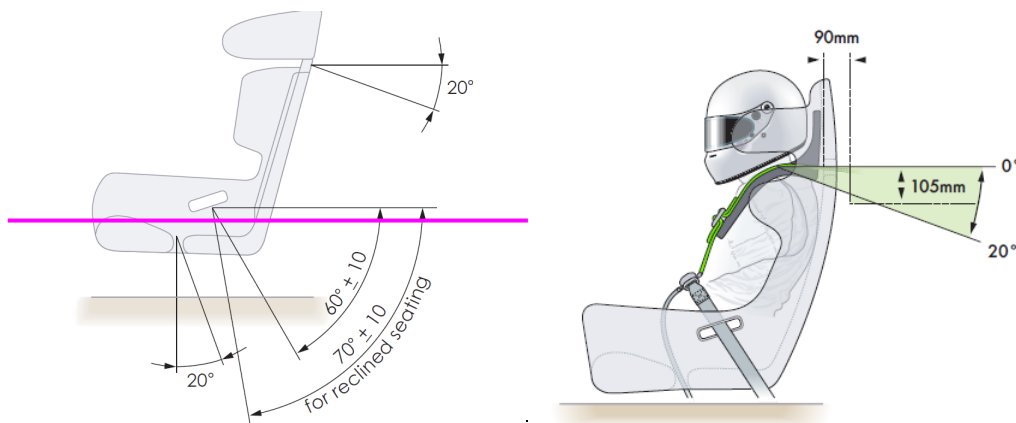

Figure 13 Side view to show recommended belt angles

When using a HANS® with a reclined seat (for example in an open cockpit car) it is recommended that the rear section of the shoulder strap is horizontal from the uppermost point of contact with the HANS-belt-bearing-surface to the anchorage point on the car, preferably a 0° angle, angles between 0° and 10° **are being** acceptable, as shown in Figure 14.

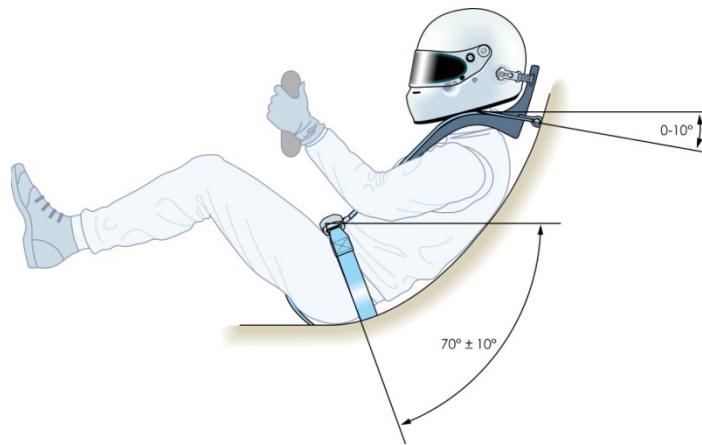

Figure 14 recommended belt angle for open cockpit cars

4.2.6. Shoulder belt angles for harnesses with 8 or 9 attachment points to the vehicle – side and top view

~~In the case of~~ **When** double shoulder belts **are used** belts HANS®, with **a** reclined seat (for example in a for open cockpit car), the body-belt anchorage points ~~should~~ **shall** be positioned 60mm +/- 15mm below the HANS-belt anchorage points (see Figure 15).

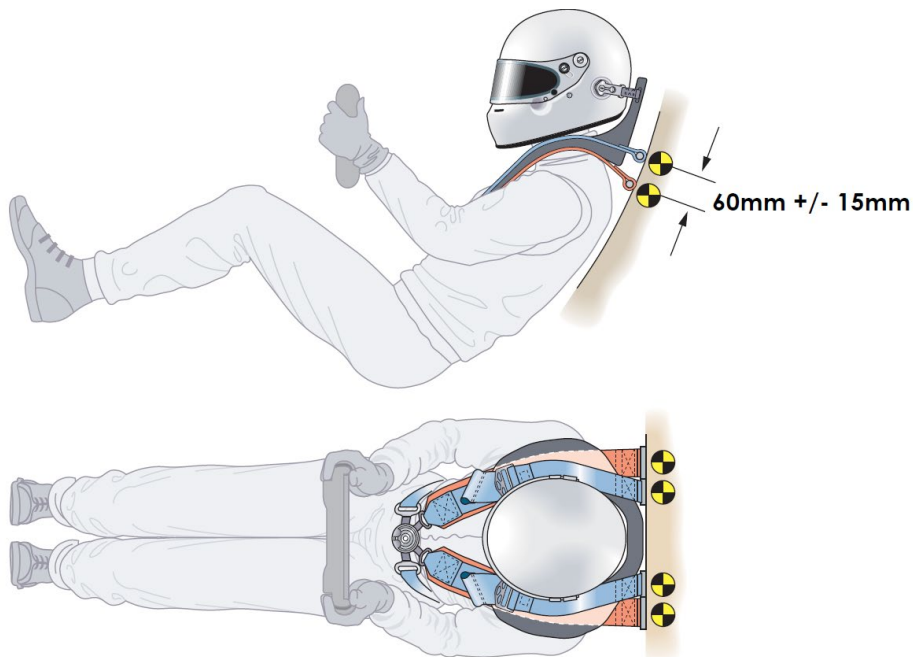

Figure 15 Installation of HANS double belts in cars where ($X < 200\text{mm}$)

~~Also for~~ **When** double shoulder belts ~~harnesses but for the rest of the~~ **are used in saloon** cars, the body-belt anchorage points ~~should~~ **can** be **at** the same height as the HANS-belt anchorage points (see Figure 16).

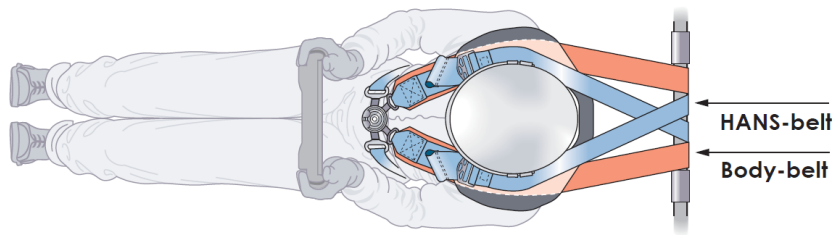

Figure 16 Installation of HANS double belts in cars where ($X > 200\text{mm}$)

In both cases ($X < 200\text{mm}$ and $X > 200\text{mm}$), the HANS-belts ~~should~~ **shall** be installed as defined in [section 4.2.4](#) for the shoulder belt at the beginning of this section.

If the HANS-belts and body-belts are installed on the same roll cage tube, the HANS-belts shall ~~respect the dimensions given by the equation 1~~ **be installed as defined in section 4.2.4** and **should shall** be attached to the tube inboard of the body-belts, as shown in Figure 16. The body-belts may, exceptionally, be installed with a greater dimension Y if necessary to accommodate this, up to the point of being parallel to each other, but not divergent.

4.3. Headrests and cockpit surrounds with HANS®

In order to ensure compatibility with the rear headrest, sufficient clearance is necessary between the rear of the HANS® and the seatback bulkhead or top of the seat. **The** HANS® worn by the driver may not be less than 25mm away from any structural part of the car when seated in **the** normal driving position.

4.4. Car evacuation with HANS®

It is essential to practice rapid evacuations from the car with full race equipment fitted (including race attire, steering wheel, radio system and drink**ing** system if applicable). This will help to ensure successful emergency evacuation, in the case of an accident.

5. Life of HANS®

Always follow the instructions of the manufacturer for the maintenance of the HANS®.

After frontal impacts, or frontal **impacts** with a yaw angle of up to 45° , ~~impacts~~ the tethers **should shall** be replaced or sooner if wear is observed.

After a severe impact that involves loading of the HANS®, it is recommended to inspect the helmet and HANS®. The respective manufacturers may be able to provide an inspection service to determine whether the helmet or HANS® has suffered any damage during less severe impacts.

An accident is considered severe if it is a frontal or frontal with an angle impact with the estimated impact speed over 50kph.